



CabParts

Your Custom Cabinet Factory



.....
2025-A CATALOG



3	INTRODUCTION
4	TERMS & CONDITIONS
5	GENERAL INFORMATION
6	STOCK CASE MATERIAL
7	WALL CABINETS
10	BASE CABINETS
17	VANITY CABINETS
20	DESK CABINETS
22	TALL CABINETS
27	FILLERS & PANELS
29	DOORS AND DRAWER FRONTS
35	DRAWERS AND ROLLOUTS

Contact CabParts®

716 Arrowest Road
Grand Junction, CO 81505
970.241.7682

cabparts@cabparts.com

Since 1987, CabParts® has been proudly serving building trade customers - including cabinet shops, residential and commercial builders and remodelers, architects, designers, and other cabinet related manufacturers. CabParts® is a second-generation family-owned business located in Grand Junction, Colorado.

CabParts® manufactures full-access, European style, cabinet boxes - together with drawers, doors, drawer fronts and closet systems - all to your specifications. All components are shipped flat-packed and arrive with each piece clearly labeled and ready for quick and efficient assembly.

We can also supply functional hardware, dovetailed drawer boxes and wood 5-piece doors and drawer fronts.

To become a CabParts customer and/or place your first order, please go to <https://cabparts.com/online>



DIMENSIONS TO FIT YOUR SPECIFICATIONS - Custom or standard sizing, components are built for each order and delivered ready for quick & easy assembly.



FLEXIBLE TO YOUR DESIGN - All components are configured to your specific requirements. Standard item or custom design? 32mm or custom boring patterns? Whatever specifications you need, we can provide.



RESIDENTIAL OR COMMERCIAL - Exceed your customer's expectations with casework that is at home in any building, wherever you need them – from homes to hospitals to schools to offices; whether new, remodel, or repair.



GREAT FREIGHT RATES - We are proud to call Grand Junction Colorado home, and if that sounds far away that's because it probably is. Because of our semi-remote location, we have a lot of shipping to us but not a whole lot of shipping out. This is great for our customers because we get low freight rates allowing you to keep your costs down.

Terms and Conditions

Please note, you must be a building trade-related professional to order from CabParts®. Verification of your trade relation, business and tax status will be required in order to establish a new account with us. We sell wholesale, not retail, business-to-business. If you are a homeowner, please have your building trade professional contact us to arrange purchasing through CabParts®.

ORDERS AND QUOTES

- Orders will be placed in line for production upon receipt of your Order Confirmation and an initial 50% or complete payment.
- CabParts® makes every reasonable effort to ship on, or before, the projected ship date shown in your Order Confirmation. However, the actual date may vary.
- Quotes do not receive a projected ship date and are not entered into production. Quotes are valid for only 30 days from the date of submittal.
- CabParts® cannot take phone orders.

PAYMENT

- CabParts® requires a minimum 50% deposit due at approval for production. Any balance is due prior to shipping. CabParts® encourages payment of 100% at time of approval to avoid shipping delays.
- Payment may be made by company check, cashier's check, or credit/debit card through our Merchant One payment portal. We accept Visa, MasterCard, Discover, and American Express.
- Delay of the deposit will affect production timing and may affect shipping date.

RETURNS

- Authorization must be obtained from CabParts® within 10 business days of delivery, for the return of any CabParts® product, including hardware.
- Any parts made to order or made with special order material are not returnable unless defective.
- All returns, unless for defects, are subject to a restock fee and the customer must pay return shipping costs

SHIPPING

- Orders are shipped freight pre-paid via common carrier, ground package or may be "Will Call" at the factory. Customers may arrange their own shipping, or request "Freight Charges COD."
- Hard siding of pallets, for increased protection, is available for an additional charge and additional pallets, if requested by the customer, will be assessed a fee-per pallet.
- A Packaging & Handling Fee may be charged based on unusual packaging - for example, a small Order required to go LTL (on a pallet) vs. ground package. Freight companies may add charges for shipping tubes or pallets 93" or longer.
- All Orders are F.O.B. Grand Junction, Colorado.

WARRANTY

- CabParts® warrants the components it manufactures to be free from defects in material and workmanship, to be machined to correct size and with the correct milling to accomplish easy and accurate assembly. CabParts® makes no further warranty either expressed or implied.
- Since assembly and installation are not done by CabParts® and are beyond our control, CabParts® makes no warranties in regard to assembly or installation.

DISCLAIMER

- CabParts® will not be responsible for any expenses incurred by the customer due to unexpected delays in factory production, delivery, jobsite installation, assembly time due to incorrect parts or delay for replacement (warranty) parts, freight damage replacement parts, natural or manmade disaster or any other situation not listed here.
- CabParts® reserves the right to change pricing and/or specifications at any time.

General Information for Cabinets

CABINET BOXES are Made-To-Order (MTO) and the customer specifies the cabinet box type and configuration, including dimensions, case materials and edging, hardware, and drilling.

MATERIALS STOCKED by CabParts® include white, almond, gray, black and natural maple thermally fused laminates (TFL); pre-finished maple plywood, paint-grade maple veneer on MDF, white veneer core plywood and raw unfaced MDF.

Numerous other materials can be ordered as well – see the Cabinet Material Selections section for examples.

CASE ASSEMBLY: Choose your preferred method of Conformat screws (standard, with alignment dowels inserted) or dowel and glue (dowels factory inserted).

Dowel and glue will be applied automatically for exposed finished sides/ends on otherwise Conformat boxes.

CASE EDGE BANDING: CabParts® will apply .5mm-3mm thick PVC or ABS, laser/hot air ABS (no glue line), wood veneer, 3mm solid wood, plastic laminate edgebanding, or no edgebanding at all – your choice.

DOORS AND DRAWER FRONTS can be supplied by CabParts®, sized to fit your specific order, and made with any currently available panel material and edgebanding.

CabParts® can also provide unfinished wood five-piece door and drawer fronts in a number of wood species.

Many other door types and styles can be outsourced from a variety of high-quality manufacturers.

For **BUYOUT DOORS AND DRAWER FRONTS** CabParts® will supply a listing of suggested sizes (may not currently be available)

DRAWER BOXES are sized to fit the cabinet box and the guide hardware chosen in your order.

Standard drawer boxes are cut from CabParts® stock 5/8" thick melamine, with 1/4" thick bottoms. Other options, including dovetailed solid wood, dovetailed plywood and Blum Legrabox are available for your order as well. Dovetailed drawer boxes wider than 34" will have a center bottom rail added for support.

DRAWER ASSEMBLY is your choice of Conformat steel screw with guide dowels or standard dowel and glue. Both include factory preinserted dowels.

DRAWER EDGE BANDING:

Melamine drawer boxes will be edged with .5mm thick PVC to match the drawer box material.

Wood veneer (plywood or MDF core) drawer boxes will have matching .5mm thick wood veneer edging applied.

Baltic Birch type plywood drawer boxes will be left unedged as the standard.

HARDWARE: CabParts® order options include functional hardware from manufacturers such as Blum and Hafele.

If you select from CabParts® stock hardware, we guarantee it will fit and function in your CabParts® cabinet.

All hardware is subject to availability.

CABPARTS® IS NOT A RETAILER - WE SELL TO QUALIFIED TRADES, WHOLESALE ONLY.

FOR NON-TRADE SALES PLEASE TALK TO YOUR BUILDING PROFESSIONAL IF YOU WISH TO USE CABPARTS®.

Stock Case Materials



Almond



Black

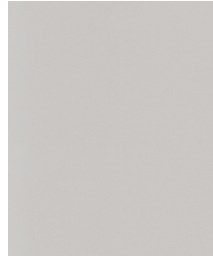

Folkstone Grey



Raw MDF



Natural Maple



Paintgrade B-1
Maple Ply



Paintgrade Maple
B-1 MDF



Prefinished Maple
C2 Ply

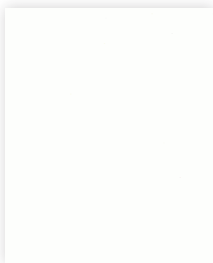

White

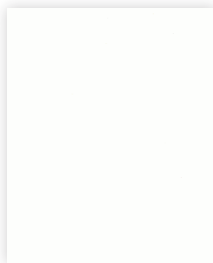

White Veneer
Core Ply

Wall Cabinets

GENERAL NOTES AND STANDARDS

Standard wall cabinets are 11-3/4" deep

CabParts® does NOT recommend single doors greater than 24" wide.

On wall cabinets, ALWAYS apply a bead of commercial quality construction adhesive or hot melt glue to the junction between the back and cabinet box parts, and/or toenail the back to the case parts in using narrow crown staple or pin nails.

Cabinets, except angled or radius corner cabinets (WA or WRAD), include nailers at top and bottom, in back



WALL CABINET UNITS

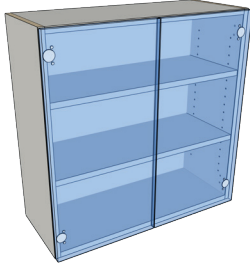

W
Wall Cabinet
with Door(s)

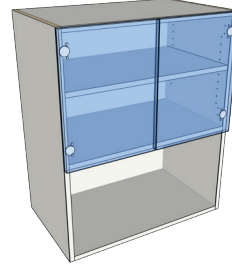

WM
Door(s) over
Microwave Shelf

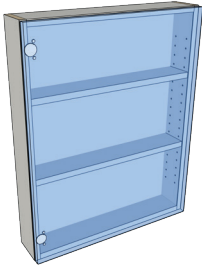

WMC
Medicine
Cabinet

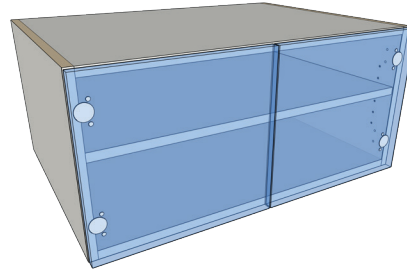

WR
Refrigerator Upper
23-3/4" deep

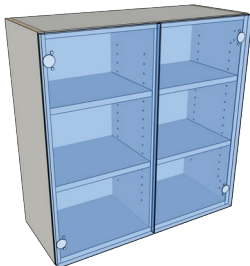

WVD
Wall with Doors
& Variable Divider

WALL CORNER UNITS

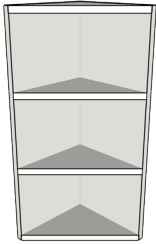

WA
Open Angled End

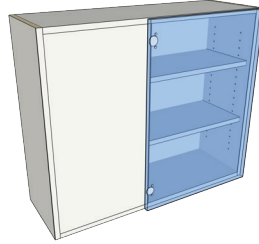

WBC-L
Blind Corner Left

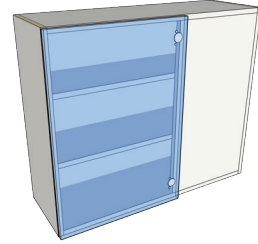

WBC-R
Blind Corner Right

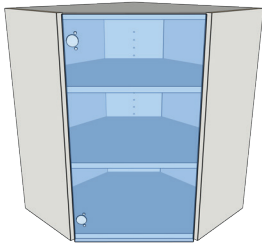

WDC
Diagonal Corner
Cabinet

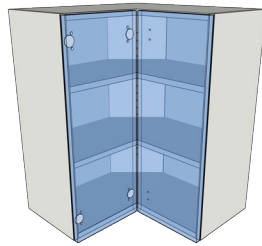

WRAC
Right Angle

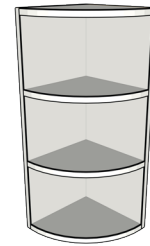

WRAD
Radius End

Base Cabinets

GENERAL NOTES AND STANDARDS

Standard base cabinets are 30-1/2" high and 23-3/4" deep

Drawer mount drilling will be for the drawer hardware selected

Cabinets, except angled or radius corner cabinets (BA or BRAD) include nailers at top and bottom, in back

CabParts® does NOT recommend single doors greater than 24" wide

BASE CABINET UNITS

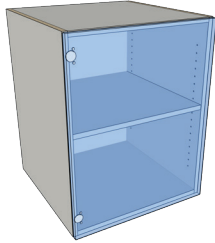

B
Base for Door(s)

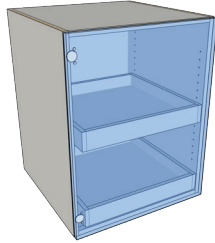

B-RO
Base for Door(s)
with Rollout(s)



B1
Drawer
Over Door(s)



B1-RO
B1 with Rollouts

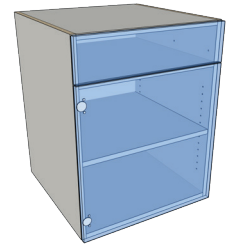

B1-FX
B1 with Fixed
Shelf

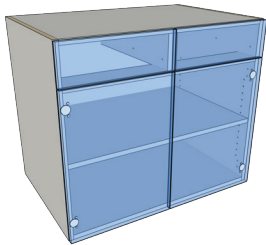

B2
Two Drawers
over Doors

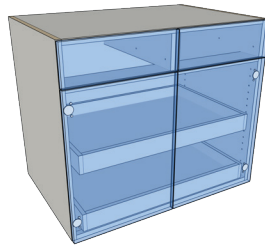

B2-RO
Two Drawers over
Doors with Rollouts



B2D
Stack of Two
Drawers over Door(s)

BASE CABINET UNITS

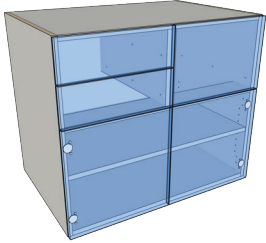

B3D-L
Three Drawers (2 LT)
over Door(s)

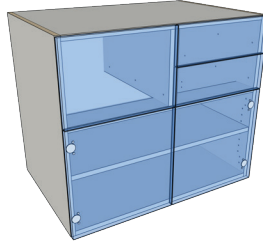

B3D-R
Three Drawers (2 RT)
over Door(s)

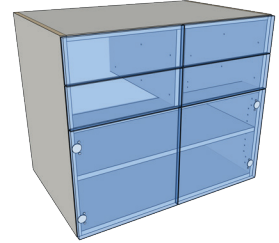

B4D
Four Drawers (2 RT, 2 LT)
over Door(s)

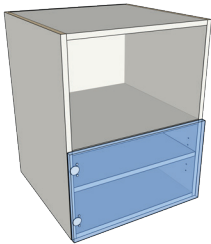

BFX-Doors
Top Opening over Door(s)

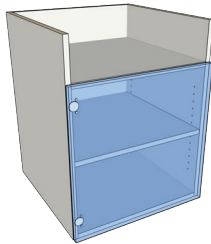

BRC-Doors
Range over Door(s)

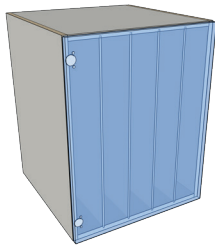

BT
Tray with Tall Door(s)

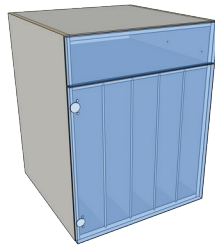

BT1
Tray with Drawer
over Door(s)

BASE SINK CABINET UNITS

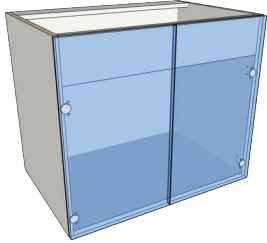

BS
Sink with Tall Door(s)

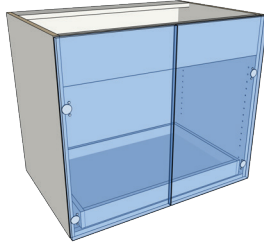

BS-RO
BS with Rollout

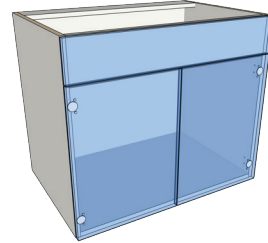

BS1F
Sink, False Front
over Door(s)

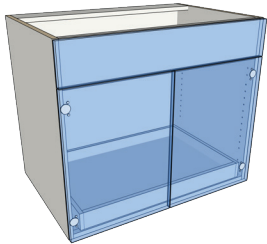

BS1F-RO
BS1F with Rollouts

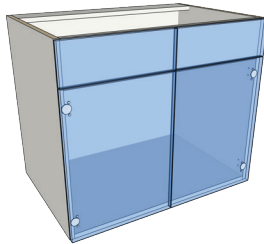

BS2F
Sink, Two False Fronts
over Door(s)

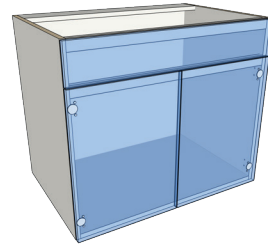

BSTO
Sink with Tilt-Out
over Door(s)

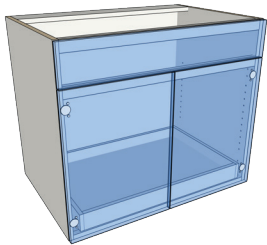

BSTO-RO
BSTO with Rollouts

BASE DRAWER UNITS

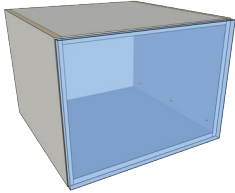

B-D1
Single Drawer

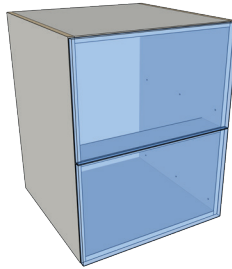

B-D2
Stack of 2 Drawers

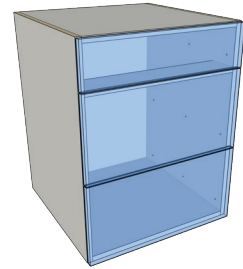

B-D3
Stack of 3 Drawers



B-D4
Stack of 4 Drawers

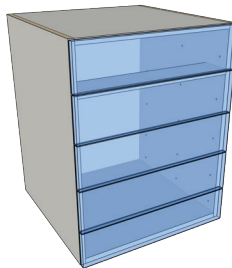

B-D5
Stack of 5 Drawers

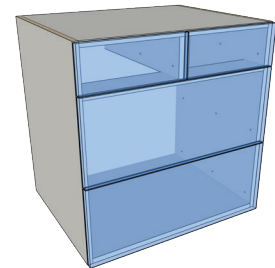

B2-D2
2 Drawers over
2 Drawers

BASE DRAWER UNITS

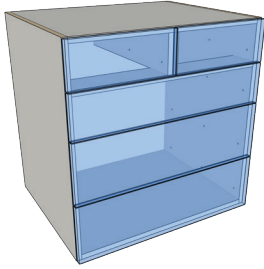

B2-D3
2 Drawers over
3 Drawers

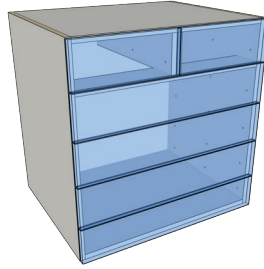

B2-D4
2 Drawers over
4 Drawers

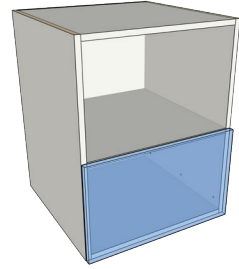

BFX-D1
Top Opening
over Drawer

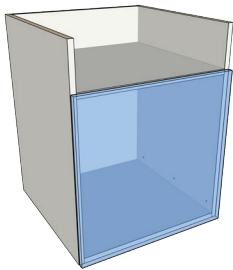

BRC-D1
Range over Drawer

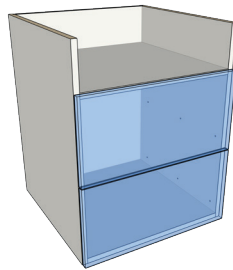

BRC-D2
Range over 2 Drawers

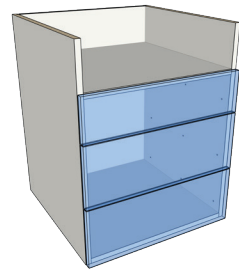

BRC-D3
Range over 3 Drawers

BASE CORNER UNITS

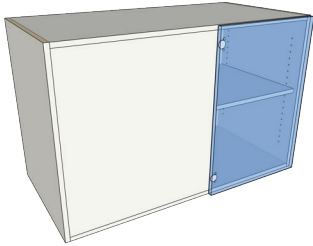

BBC-L
Blind Corner Left

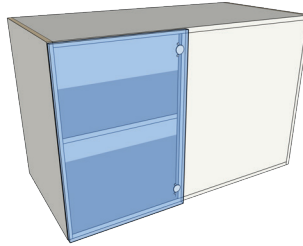

BBC-R
Blind Corner Right

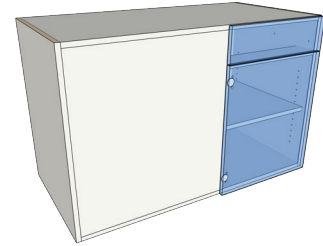

BBC1-L
Blind Corner with
Drawer Left

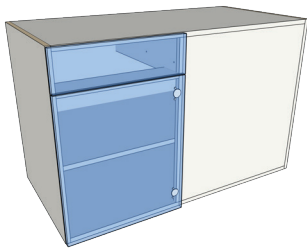

BBC1-R
Blind Corner with
Drawer Right

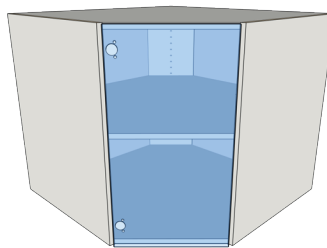

BDC
Diagonal

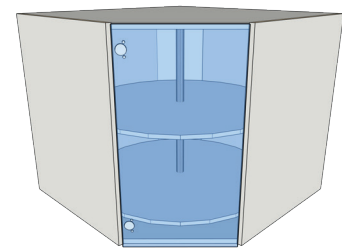

BDC-LS
Diagonal with
Lazy Susan

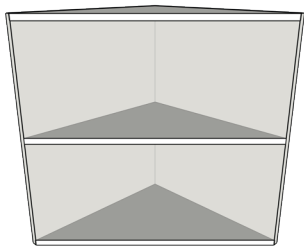

BA
Open Angle

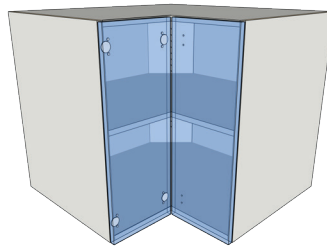

BRAC
Right Angle

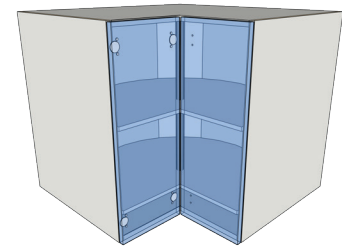

BRAC-LS
Right Angle with
Lazy Susan

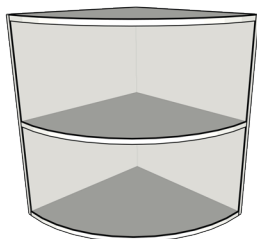

BRAD
Open Radius

Vanity Cabinets

GENERAL NOTES AND STANDARDS

Standard vanity box is 26-1/2" high and 20-3/4" deep

Drawer mount drilling will be for the drawer hardware selected

Cabinets include nailers at top and bottom, in back

CabParts® does NOT recommend single doors greater than 24" wide

VANITY CABINET UNITS

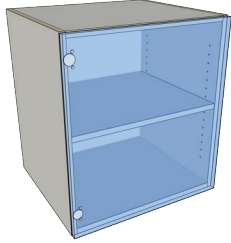

VB
Door(s)

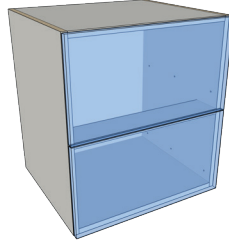

VB-D2
Stack of 2 Drawers

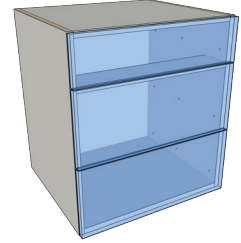

VB-D3
Stack of 3 Drawers

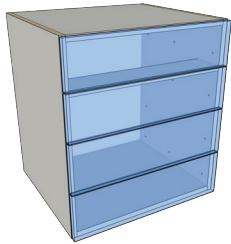

VB-D4
Stack of 4 Drawers



VB1
Drawer over Door(s)

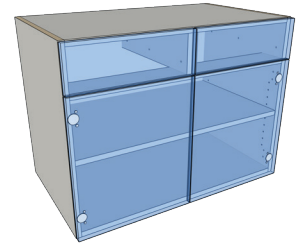

VB2
2 Drawers over 2 Door(s)

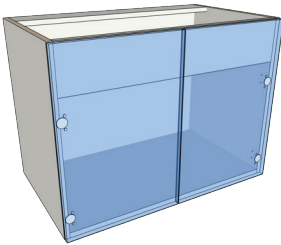

VS
Sink with Full-Height
Door(s)

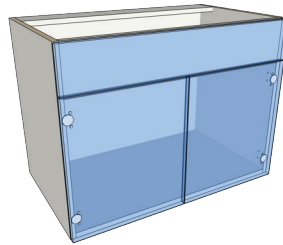

VS1F
Sink, False Front
over Door(s)

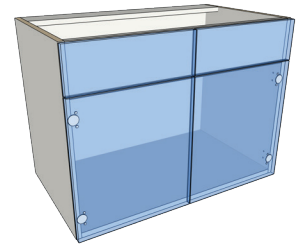

VS2F
Sink, 2 False Fronts
over Door(s)

VANITY CABINET UNITS

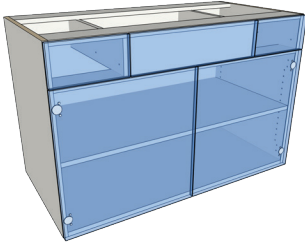

VSDA
Drawers, False Front,
and Door(s)

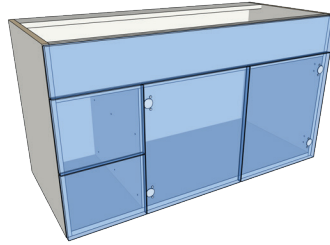

VSD-B-L
False Front, Drawers (LT)
and Door(s) (RT)

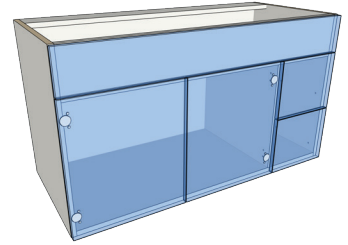

VSD-B-R
False Front, Drawers (RT)
and Door(s) (LT)

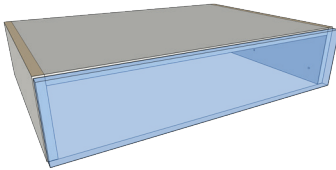

VPD1
Pencil 1 Drawer

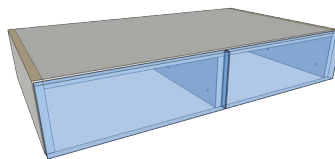

VPD2
Pencil 2 Drawers

Desk Cabinets

GENERAL NOTES AND STANDARDS

Standard desk cabinets are 24 1/2" high and 20 3/4" deep

Drawer mount drilling will be for the drawer hardware selected

Cabinets include inset nailers at top and bottom, in back

CabParts® does NOT recommend single doors greater than 24" wide

Desk top drawer front height default is 6-1/8" unless overridden by the "Top Drawer Front Height" preset.



DESK CABINET UNITS

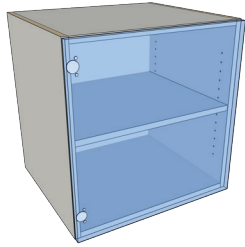

DB
Door(s)



DB1
Drawer over Door(s)

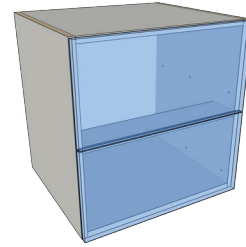

DB-D2
Stack of 2 Drawers

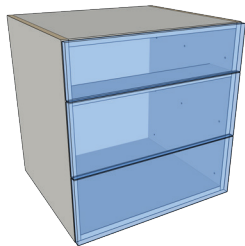

DB-D3
Stack of 3 Drawers

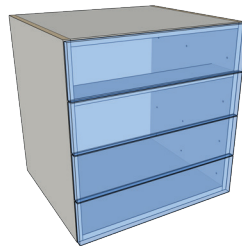

DB-D4
Stack of 4 Drawers

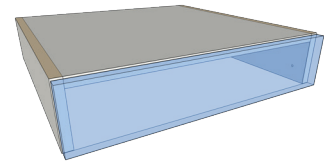

DPD1
Pencil 1 Drawer

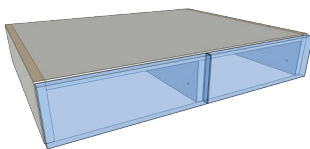

DPD2
Pencil 2 Drawers

Tall Cabinets

GENERAL NOTES AND STANDARDS

Standard tall cabinet are 80" high and 23-3/4" deep

Drawer mount drilling will be for the drawer hardware selected

Cabinets include 3 nailers for use at top, bottom, and behind fixed shelves, in back.

CabParts® does NOT recommend single doors greater than 24" wide

TALL CABINET UNITS

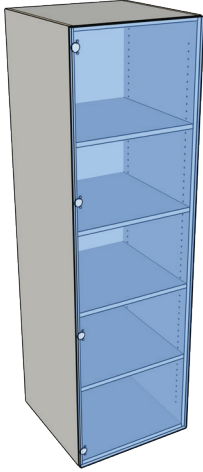

T
Tall, No Fixed Shelf

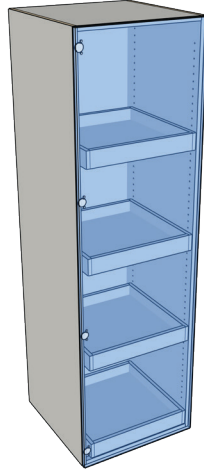

T-RO
T with Rollouts

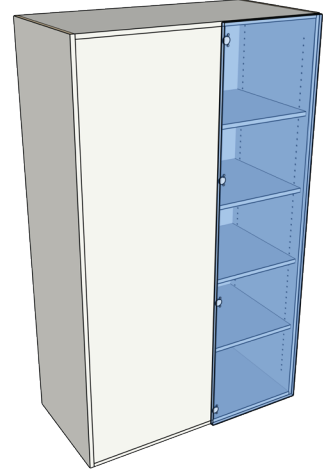

TBC-L
Blind Corner Left

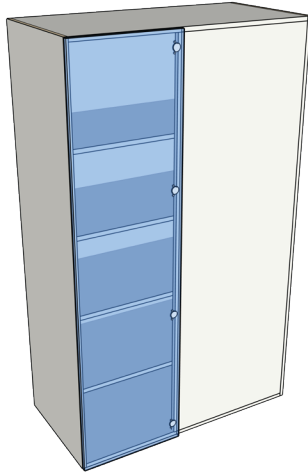

TBC-R
Blind Corner Right

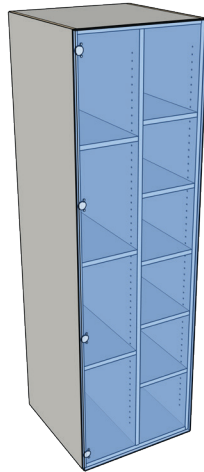

TVD
Tall, with Adjustable
Divider

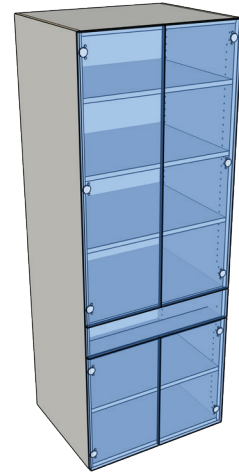

TD-B1
Door(s), Drawer, Door(s)

TALL CABINET UNITS

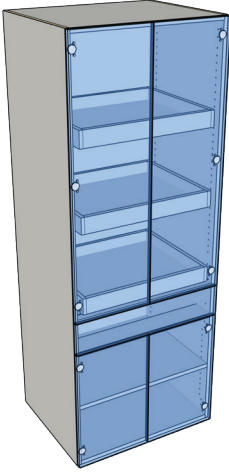

TD-B1-RO
TD-D1 with Rollouts

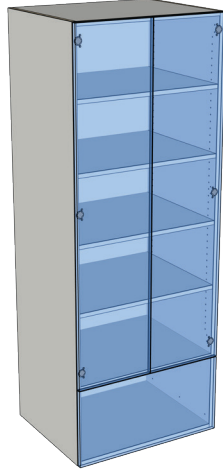

TD-D1
Door(s) over 1 Drawer

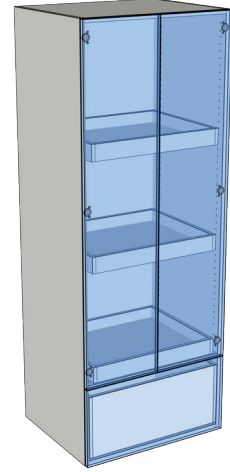

TD-D1-RO
TD-D1 with Rollouts

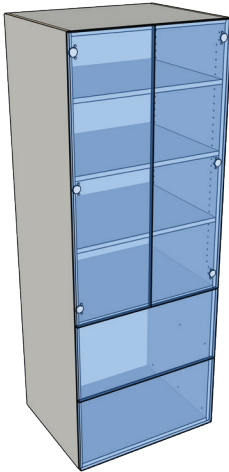

TD-D2
Door(s) over 2 Drawers

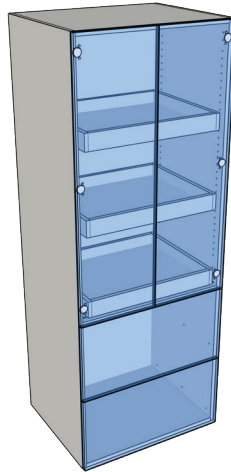

TD-D2-RO
TD-D2 with Rollouts

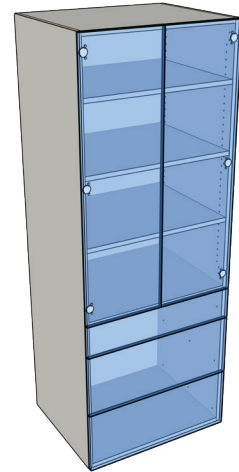

TD-D3
Door(s) over 3 Drawers

TALL CABINET UNITS

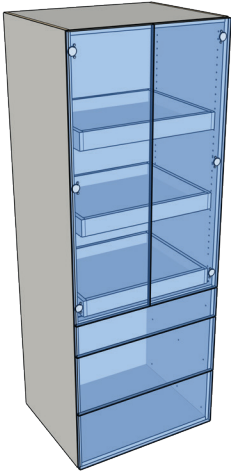

TD-D3-RO
TD-D3 with Rollouts

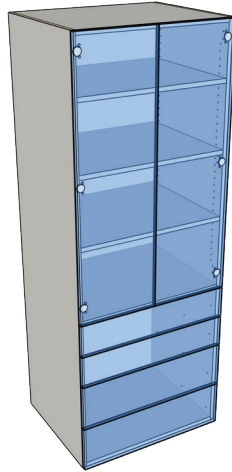

TD-D4
Door(s) over 4 Drawers

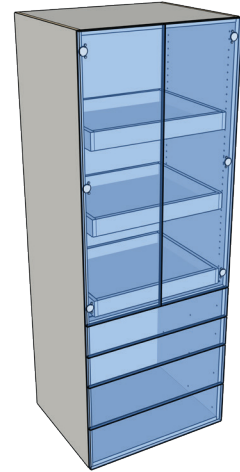

TD-D4-RO
TD-D4 with Rollouts

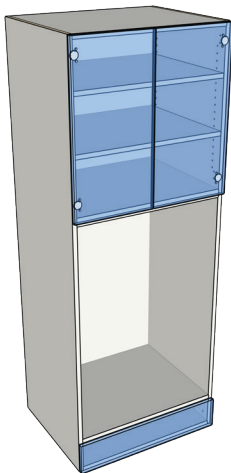

TO-D1
Oven over 1 Drawer

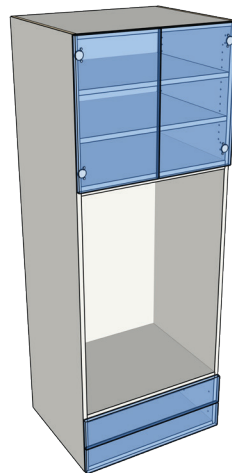

TO-D2
Oven over 2 Drawers

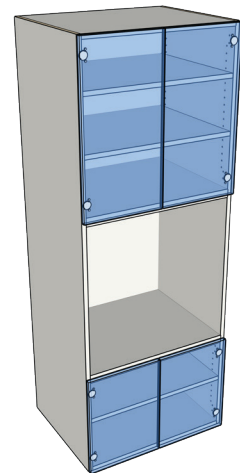

TO-DOORS
Oven over Doors

TALL CABINET UNITS

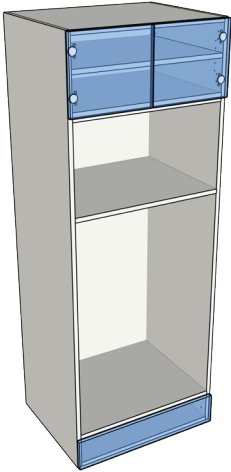

TOM-D1
MW Oven over 1 Drawer

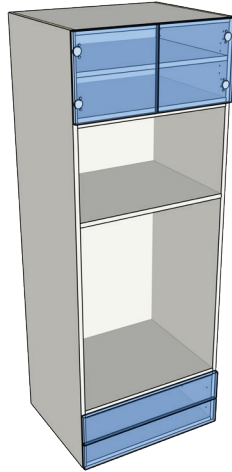

TOM-D2
MW Oven over 2 Drawers

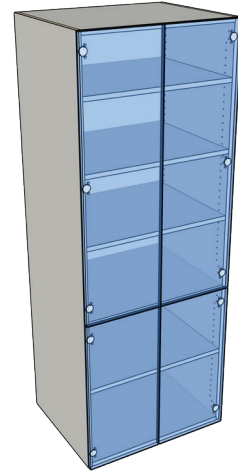

TS-TU
Tall Storage
or Utility

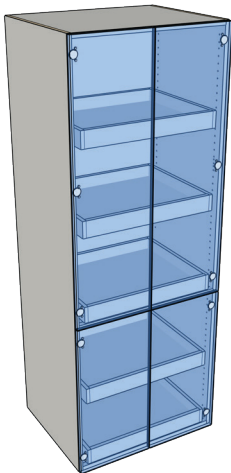

TS-TU-RO
TS-TU with Rollouts

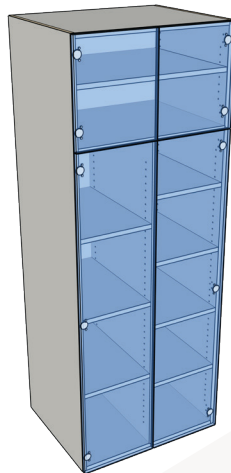

TSVD
Tall Storage with
Variable Divider

Fillers

GENERAL NOTES AND STANDARDS

- Material may be any available panel material
- Edged per customer requirements
- Sized per customer requirements

Panels, Cut to Size

GENERAL NOTES AND STANDARDS

- Material may be any available panel material
- Edged per customer requirements
- Cut to size per customer specification

FILLERS



FILLER
Straight Filler

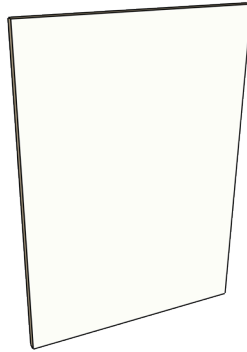

**FINISHED PANEL /
TOE KICK PANEL**
Panel with Finished End



WALL FILLER
Filler with Bottom Return

PANELS, CUT TO SIZE

- **Cut to size panels** may be ordered from any stocked CabParts® sheet goods, or from special ordered materials. Customer must specify panel size by width and height.
- Minimum **width** 3" – minimum **height** is 10"
- If edgebanded, customer must specify edges to be banded and the edgeband selected:

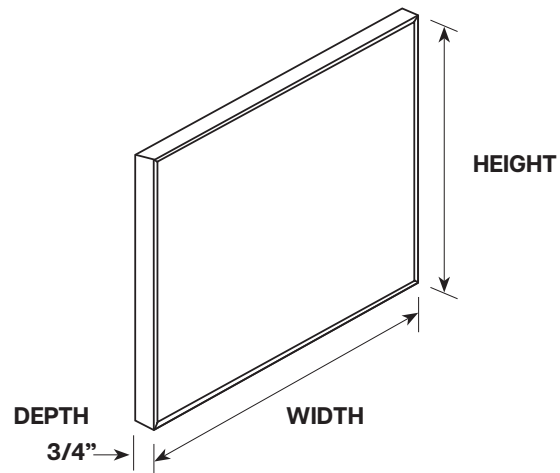
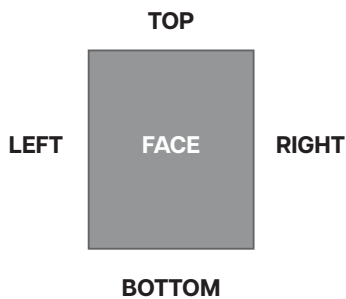

Doors & Drawer Fronts

GENERAL NOTES AND STANDARDS

Customer chooses panel material, finish, and edgeband treatment

CabParts® offers many options for Doors & Drawer Fronts, see chart on following pages

CabParts® provides a complimentary Door & Drawer Front size list for each order (may not be currently available)

All doors may be drilled for Euro style hinges, for example: Blum brand

Drawer Fronts may be milled for MetaBox, TandemBox, LegraBox, Moovit, etc

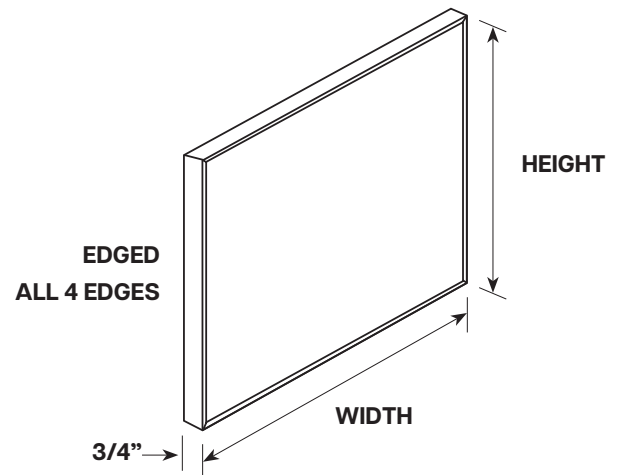

CabParts® Door & Drawer Front Choices

DOOR & DRAWER FRONT MATERIAL	.5 PVC/ABS	1.2mm No Glue	3mm PVC	.5mm Wood Veneer	3mm Solid Wood	Plastic Laminate	5-Piece Fronts
CabParts® Stocked Melamines	\$	\$\$\$	\$	\$	\$\$\$	\$\$\$	
Non-Stocked Melamines	\$\$-\$\$\$	\$\$\$-\$\$\$\$	\$\$\$	\$-\$\$\$	\$\$\$-\$\$\$\$	\$\$\$-\$\$\$\$	
MDF Veneered or Raw	\$\$		\$\$\$	\$\$	\$\$\$	\$\$\$\$	
Veneer on Plywood	\$\$\$		\$\$\$	\$\$\$	\$\$\$		
Pre-Finished Veneer on Plywood	\$\$		\$\$\$	\$\$	\$\$\$		
High Gloss Acrylic		\$\$\$\$			\$\$\$		
Ultra Matte Acrylic		\$\$\$\$			\$\$\$\$		
Plastic Laminate, Laid Up, G2S	\$\$\$	\$\$\$\$	\$\$\$\$		\$\$\$\$	\$\$\$\$	
5-Piece Unfinished Wood (see Order Form)							\$\$
5-Piece Finished Wood							\$\$\$\$

MELAMINE

CabParts® Stock

- White
- Almond
- Gray
- Black
- Natural Maple

Melamine Sources

- Roucke
- Cleaf
- Salt
- Stevens
- Egger

Some products may not be available in small quantities; check with CabParts® .

MDF/PLYWOOD

CabParts® Stock

- C2 Maple ply, prefinished
- B1 Maple, MDF unfinished
- Raw MDF

Additional MDF/ Plywood Materials

- CabParts® can source nearly any veneer, in any grade, unfinished on MDF or Plywood core to fit your needs. Limited availability of prefinished veneers.
- Check with CabParts® for your requirements.

ACRYLIC

- High Gloss, one face or two
- Matte Finish, one face or two
- Check with CabParts® for color, finish, and edgeband choices

5-PIECE UNFINISHED WOOD

- See Order Form for design choices
- 13 basic wood species available
- Fronts provided unfinished
- All fronts are sized specific to your order or to your specified sizes

Wood Doors & Drawer Fronts

CabParts® is pleased to make available, in addition to our flat panel laminate and melamine offerings, a selection of **unfinished** wood doors and drawer fronts in various species and styles.

We can help you reduce your time per job, produce more, and sell more, all while maintaining your standards for high quality.

- Each unit is cut to size, sanded and inspected one at a time, ensuring that you receive products you will be proud to use in your jobs.
- All stile and rail joints are glued and doweled – not just pinned – for extra quality and strength.
- All solid wood panels are allowed to “float” within the frame with clearance on all sides to allow for expansion and contraction caused by changes of temperature and/or humidity.
- Arches are geometrically designed to maintain uniform style regardless of widths.
- Sizes can be in inches or millimeters. We will cut to the nearest 1/32” or whole millimeter and sizes are guaranteed to within +/- 1/32” of the given measurements.
- Standard thickness is 13/16”.
- CabParts® guarantees material and workmanship for one year from date of shipment. This guarantee is voided by improper storage, handling, or finishing on the part of the customer or final consumer.
- Warpage is guaranteed to 3/16”, however cabinet doors over 24 inches wide or 44 inches tall are not guaranteed against warpage. Warp is any distortion of the door itself on width, length or diagonal and is measured by placing a straight edge on the concave face and determining the maximum distance from straight edge to door face. Warp does not refer to the relationship of the door to the face frame or cabinet box.
- The warranty covers replacement or repair of doors or drawer fronts in an unfinished state and in good condition as originally delivered F.O.B. our factory. Our liability will be limited to the net invoice price of the defective items, and CabParts® cannot be responsible for any other damages or loss of profits.
- Changes or cancellations after order approval may incur additional charges.
- Pricing is to the actual square footage, with a minimum door or drawer front charge of two square feet per piece. Inside and outside profiles are included.
- Doors over 48” tall or 24” wide will have a center rail or stile included and will incur an upcharge. If placing that rail or stile at other than the center (standard), the location must be specifically and clearly noted in the order.
- Glass door frames are rabbeted to receive the glass. Glass and stop are not provided, but rubber stop is optional – specify glass thickness.
- Paint grade is mill choice, with MDF panels (plywood optional).
- Available species:
 - Alder (clear or rustic)
 - Cherry
 - Hickory (heart, rustic heart, calico)
 - Maple
 - Oak, red
 - Oak, white
 - Pine (knotty)
 - Walnut (clear or rustic)
 - Paint Grade / MDF or plywood panel

WOOD DOOR STYLES

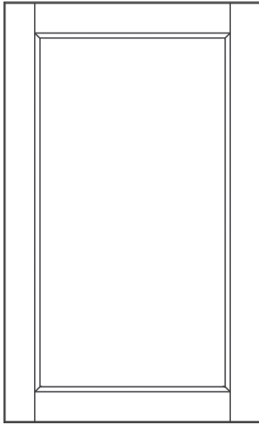

SFP

Flat Inset Panel Doors

1/4" panel (plywood or MDF)

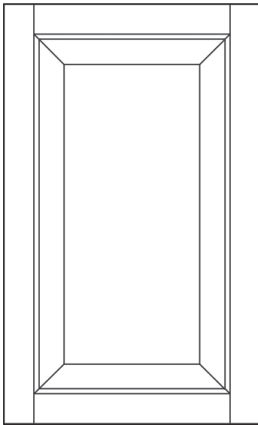

SRP

Raised Panel Doors

Back-cut raised panel available
(PR-6)

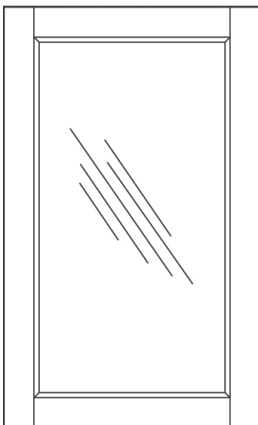

SGP

Glass Frame Doors

Rubber stop optional,
specify thickness of your glass
(not included)

**For all doors, a middle rail
or stile is optional; specify
location if different from
standard (centered)**

WOOD DRAWER FRONT STYLES

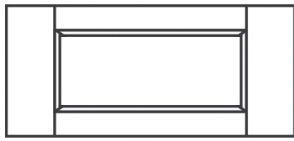

SFP-DF

Flat Panel Drawer Front

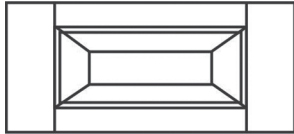

SRP-DF

Raised Panel Drawer Front

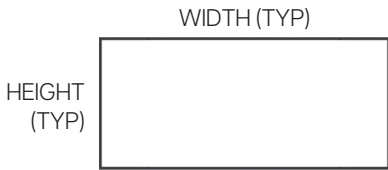

SLAB-DF

Slab Drawer Front

NOTE

The minimum height is 4" for SFP-DF and 6-1/8" for SRP-DF drawer fronts.

Standard Panel drawer front top and bottom standard rails are 1-1/4" high.

EDGE PROFILES

Outside Edge



E-1 1/8" RADIUS



E-4 1/4" RADIUS

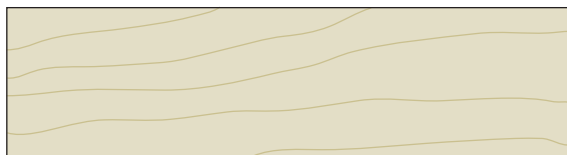

E-2 SQUARE



E-5



E-3



E-6

EDGE & PANEL PROFILES

Inside

ALL ARE 2 1/4" WIDE UNLESS OTHERWISE NOTED



W (2 3/8")



T



S



O



B

Raised Panel

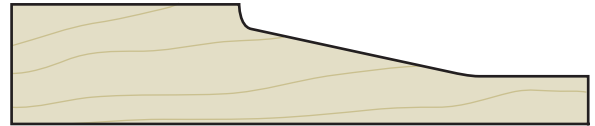

PR-1

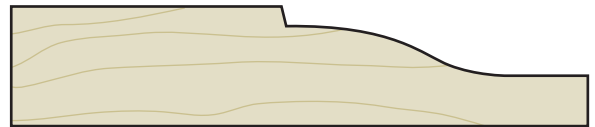

PR-2

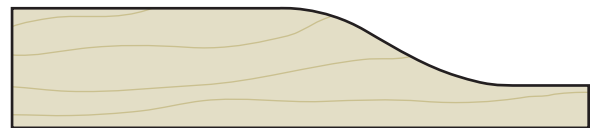

PR-3



PR-4



PR-5



PR-6 (back cut)

Drawer Boxes & Rollout Shelves

GENERAL NOTES AND STANDARDS

Standard material will be 5/8" thick, G2S melamines from CabParts® stock

Choose assembly method: Dowel & Glue or Conformat Screw

All dowels will be factory inserted

CabParts® offers many options for Drawer Boxes, see chart on following pages

Rollout Shelves include spacer blocks for door edge and hinge clearance

Customer specifies materials, type of Drawer / Rollout and construction

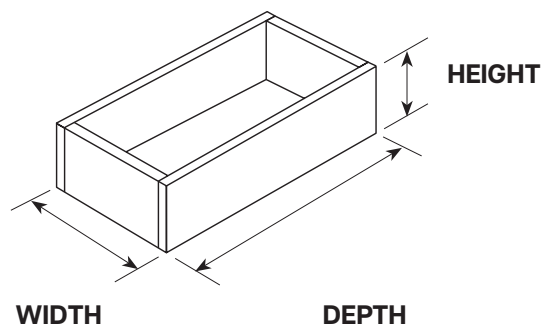

CABPARTS® DRAWER BOXES & ROLLOUT SHELVES

JOINERY						
MATERIAL	Sides & Ends Thickness	Dowel & Glue	Confirmat	Dovetailed	Drawer System	COST SCALE
Melamine	5/8"	.	.			\$
Birch Ply	5/8" (16mm)	.	.	.		\$\$
Solid Wood	5/8"			.		\$\$\$
Legra Box					.	\$\$\$

MELAMINE

CabParts® Stock

- White
- Almond
- Gray
- Black
- Natural Maple
- Salt Anthracite Linen
- Salt Buff Linen
- Salt Magnolia Linen

DOVETAILED

- Maple Hardwood
- Beech Hardwood
- Birch Plywood

DRAWER SLIDES

- LegraBox
- Tandem
- Blumotion (Soft Close)
- Euro Epoxy 3/4" Extension
- Ball Bearing Pro 100
- Ball Bearing Pro 100 (Soft Close)
- Other systems may be available; check with CabParts®.

• Some products may not be available in small quantities; check with CabParts®.

NOTE

- CabParts® Drawer Boxes and Rollout Shelves wider than 34-1/8" will receive a 5/8" thick, rabbeted-in bottom for strength, depending on material chosen.
- Dovetail Drawer Boxes wider than 34" will receive a support rail at center, under the bottom.

Important Notice to Catalog Holders

This catalog is copyrighted and intended solely to facilitate doing business with **CabParts**®. It may be freely distributed or reproduced, so long as all references and labeling remain intact and unaltered and **CabParts**® is given full credit in any materials distributed or reproduced in whole or in part.

It is not to be used for commercial purposes by any other business or personal entity.

The technical data presented in regard to dimensions, drawings, suggested assembly techniques, etc., are non-binding and subject to change at any time. **CabParts**® reserves the right to make design changes and improvements and to change specifications and/or prices without notice.

CabParts® does not accept any responsibility for any typographical or other error which may occur in the production of this catalog.



Your Custom Cabinet Factory

Contact CabParts®

716 Arrowest Road
Grand Junction, CO 81505
970.241.7682

cabparts@cabparts.com